

Supreme 500 HC



one₄all

LED GROW LIGHT FOR
PROFESSIONAL GROWERS

PRODUCT FOCUS

- Heat-pipe system passive cooling
- Vaste range of silicone lenses
- Excellent light concentration and deep penetration on the crop
- Upgradability over the time
- Low power consumption and lower heating emission in comparison with traditional lamp source

Dimensions

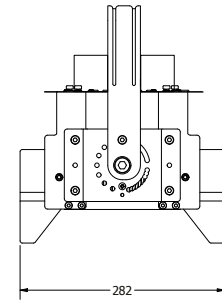
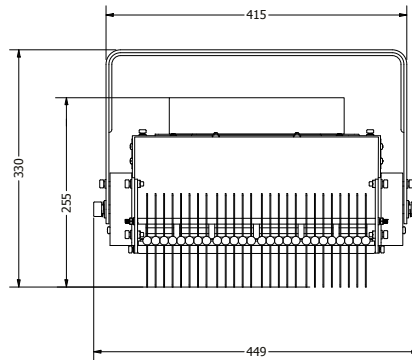

Mechanical features

BODY	Aluminum
COOLING SYSTEM	Natural convection - Heat Pipe
IP RATE	IP65
WEIGHT	10 Kg

Electrical features

INPUT POWER	100-240 Vac with PFC
PFC	Active > 90
NOMINAL POWER ABSORPTION	500 W
OPTIONAL DIMMING*	1-10V

* Upon request other dimming Systems are available

Lighting features

	FULL SPECTRUM HC	PW SPECTRUM HC	PRB SPECTRUM HC
SOURCE	n°2 COB LED	n°2 COB LED	n°2 COB LED
LUMINOUS FLUX	65754 lm (Ta 30°C)	41943 lm (Ta 30°C)	26609 lm (Ta 30°C)
PHOTOSYNTHETIC PHOTON FLUX (PPF)	1155 µmol/s (Ta 30°C)	805 µmol/s (Ta 30°C)	770 µmol/s (Ta 30°C)
EFFICIENCY (PPF/W)	2,3 µmol/J (Ta 30°C)	1,6 µmol/J (Ta 30°C)	1,5 µmol/J (Ta 30°C)
LENS TYPE	60° / 90° / Square 120°	60° / 90° / Square 120°	60° / 90° / Square 120°

Spectrum: PW, PRB, FULL SPECTRUM

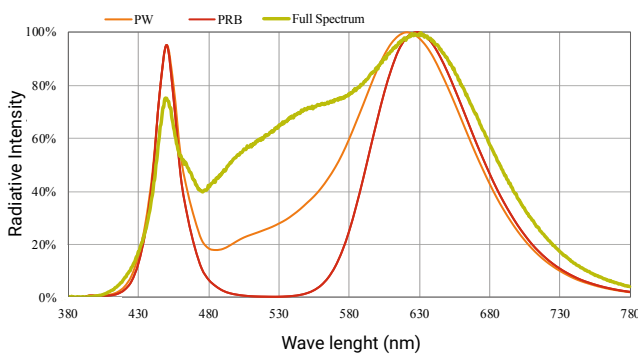

Information about the lens:

- Anti-Vandal protection IK10
- Life long warranty againts yellowing effect UL 94
- UV Resistant
- Anti-Glare

ONE 4 ALL S.r.l.

Cascina A valle, 23 | 15038, Ottiglio Monferrato (AL) | ITALY | +39 0142 921338
www.one4all.it | info@one4all.it